

VOLTAGE REGULATOR WITH ON/OFF SWITCH

FEATURES

- High Voltage Precision at $\pm 2.0\%$
- Active Low On/Off Control
- Very Low Dropout Voltage 80 mV at 30 mA
- Very Low Noise
- Very Small SOT-23L or SOT-89-5 Surface Mount Packages
- Internal Thermal Shutdown
- Short Circuit Protection

DESCRIPTION

The TK113xxB is a low dropout linear regulator with a built-in electronic switch. The device is in the ON state when the control pin is pulled to a low level. An external capacitor can be connected to the noise bypass pin to lower the output noise level to 30 μ Vrms.

An internal PNP pass transistor is used to achieve a low dropout voltage of 80 mV (typ.) at 30 mA load current. The TK113xxB has a very low quiescent current of 170 μ A at no load and 1 mA with a 30 mA load. The standby current is typically 100 nA. The internal thermal shutdown circuitry limits the junction temperature to below 150 $^{\circ}$ C. The load current is internally monitored and the device will shutdown in the presence of a short circuit or overcurrent condition at the output.

APPLICATIONS

- Battery Powered Systems
- Cellular Telephones
- Pagers
- Personal Communications Equipment
- Portable Instrumentation
- Portable Consumer Equipment
- Radio Control Systems
- Toys
- Low Voltage Systems

The TK113xxB is available in either 6 pin SOT-23L or 5 pin SOT-89-5 surface mount packages.

TK113XXB

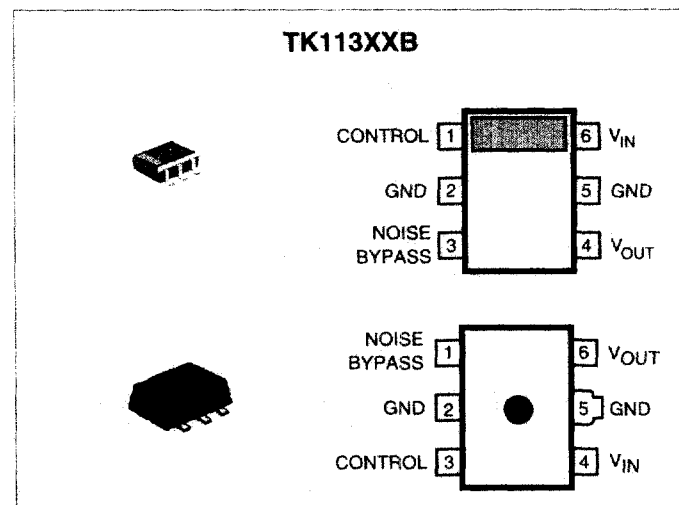

ORDERING INFORMATION

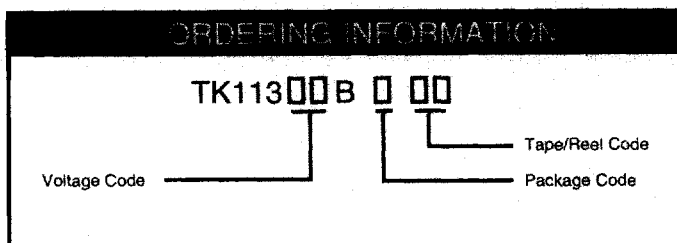

VOLTAGE CODE		PACKAGE CODE	TAPE/REEL CODE
20 = 2.0 V	37 = 3.7 V	M: SOT-23L	BX: Bulk/Bag
21 = 2.1 V	38 = 3.8 V	U: SOT-89-5	TL: Tape Left (SOT-23L)
22 = 2.2 V	39 = 3.9 V		TB: Tape Bottom (SOT-89-5)
23 = 2.3 V	40 = 4.0 V		
24 = 2.4 V	41 = 4.1 V		
25 = 2.5 V	42 = 4.2 V		
26 = 2.6 V	43 = 4.3 V		
27 = 2.7 V	44 = 4.4 V		
28 = 2.8 V	45 = 4.5 V		
29 = 2.9 V	46 = 4.6 V		
30 = 3.0 V	47 = 4.7 V		
31 = 3.1 V	48 = 4.8 V		
32 = 3.2 V	49 = 4.9 V		
33 = 3.3 V	50 = 5.0 V		
34 = 3.4 V	55 = 5.5 V		
35 = 3.5 V	60 = 6.0 V		
36 = 3.6 V	80 = 8.0 V		

BLOCK DIAGRAM

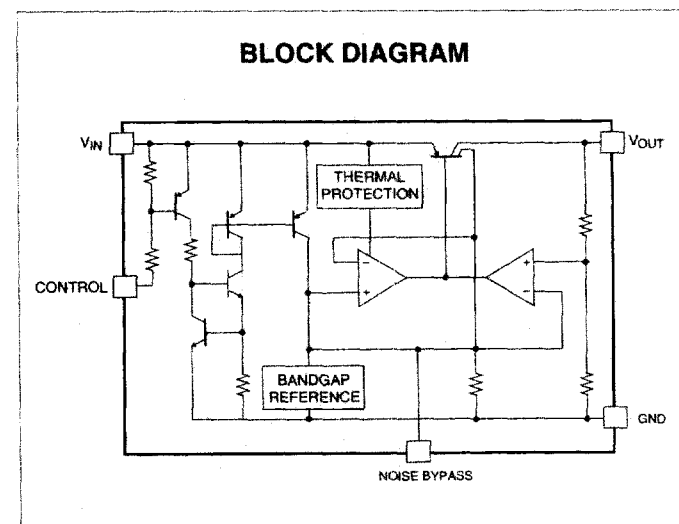

TK113xxB

ABSOLUTE MAXIMUM RATINGS

Supply Voltage	16 V	Storage Temperature Range	-55 to +150 °C
Output Current	260 mA	Operating Temperature Range	-30 to +80 °C
Reverse Bias	10 V	Voltage Range	1.8 to 14.5 V
Power Dissipation	Internal Limited	Junction Temperature	150 °C

TK113XXB ELECTRICAL CHARACTERISTICS

Test conditions: $T_A = 25\text{ °C}$, unless otherwise specified.

SYMBOL	PARAMETER	TEST CONDITIONS	MIN	TYP	MAX	UNITS
I_Q	Quiescent Current	$I_O = 0\text{ mA}$, Except I_{CONT}		170	250	μA
I_{STBY}	Standby Current	$V_{IN} = 8\text{ V}$, at output off			0.1	μA
V_O	Output Voltage	$I_O = 30\text{ mA}$	See table 1			V
Line Reg	Line Regulation	$V_O \leq 5.5\text{ V}$ (Note 3)		3.0	20	mV
Load Reg	Load Regulation	$I_O = 1\text{ mA} \rightarrow 60\text{ mA}$ (Note 1)		6	30	mV
		$I_O = 1\text{ mA} \rightarrow 100\text{ mA}$		18	90	mV
V_{DROP}	Dropout Voltage	$I_O = 60\text{ mA}$		0.12	0.24	V
I_O	Continuous Output Current	I_O when V_O drops 0.3 V from V_O (typ) (Note 1)			150	mA
I_O (PULSE)	Pulse Output Current	5 ms pulse, 12.5% duty cycle			200	mA
V_{REF}	Noise Bypass Terminal Voltage			1.25		V
Control Terminal Specification						
I_{CONT}	Control Current	Output on, $V_{CONT} = 1.8\text{ V}$		12	35	μA
V_{CONT}	Control Voltage	Output on			$V_{CC}-1.8$	V
		Output off	$V_{CC}-0.6$			V
$\Delta V_O/T_A$	Output Voltage Temperature Coefficient	$I_O = 10\text{ mA}$		0.09		mV/°C

Note 1: Refer to Definition of Terms

Note 2: Parameters with min. or max. values are 100% tested at $T_A = 25\text{ °C}$.

Note 3: For Line Regulation $V_O > 5.6\text{ V}$, Typ and Max values are 15 and 40 mV.

Ripple rejection is about 55 dB at 400 Hz when [$C_L = 10\text{ }\mu\text{F}$, $C_N = 0.1\text{ }\mu\text{F}$, $V_{NOISE} = 100\text{ mVrms}$, $V_{IN} = V_{OUT(TYP)} + 1.5\text{ V}$, $I_O = 30\text{ mA}$]. Output noise voltage can be reduced by connecting a capacitor to a noise pass terminal. Ripple rejection and noise voltage are affected by the value and characteristics of the capacitors used.

TK113xxB ELECTRICAL CHARACTERISTICS (Table 1)

Output Voltage	Voltage Code	V _{IN} Max	V _{OUT} Max	Test Voltage
2.0 V	20	1.94 V	2.06 V	3.0 V
2.1 V	21	2.04 V	2.16 V	3.1 V
2.2 V	22	2.14 V	2.26 V	3.2 V
2.3 V	23	2.24 V	2.36 V	3.3 V
2.4 V	24	2.34 V	2.46 V	3.4 V
2.5 V	25	2.44 V	2.56 V	3.5 V
2.6 V	26	2.54 V	2.66 V	3.6 V
2.7 V	27	2.64 V	2.76 V	3.7 V
2.8 V	28	2.74 V	2.86 V	3.8 V
2.9 V	29	2.84 V	2.96 V	3.9 V
3.0 V	30	2.94 V	3.06 V	4.0 V
3.1 V	31	3.04 V	3.16 V	4.1 V
3.2 V	32	3.14 V	3.26 V	4.2 V
3.3 V	33	3.24 V	3.36 V	4.3 V
3.4 V	34	3.335 V	3.465 V	4.4 V
3.5 V	35	3.435 V	3.565 V	4.5 V
3.6 V	36	3.535 V	3.665 V	4.6 V

Output Voltage	Voltage Code	V _{IN} Max	V _{OUT} Max	Test Voltage
3.7	37	3.630	3.770	4.7
3.8	38	3.725	3.875	4.8
3.9	39	3.825	3.975	4.9
4.0	40	3.920	4.080	5.0
4.1	41	4.020	4.180	5.1
4.2	42	4.120	4.280	5.2
4.3	43	4.215	4.385	5.3
4.4	44	4.315	4.485	5.4
4.5	45	4.410	4.590	5.5
4.6	46	4.510	4.690	5.6
4.7	47	4.605	4.795	5.7
4.8	48	4.705	4.895	5.8
4.9	49	4.800	5.000	5.9
5.0	50	4.900	5.100	6.0
5.5	55	5.390	5.610	6.5
6.0	60	5.880	6.120	7.0
8.0	80	7.840	8.160	9.0

TEST CIRCUITS

SOT-23L

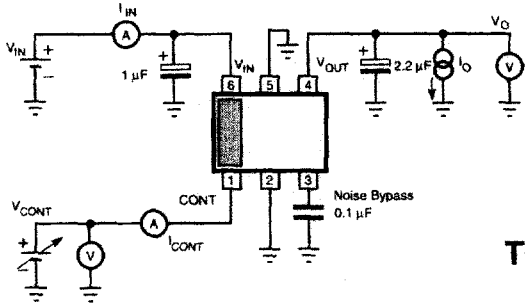

SOT-89-5

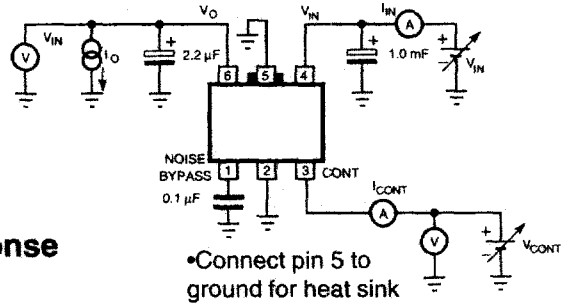

Transient Response

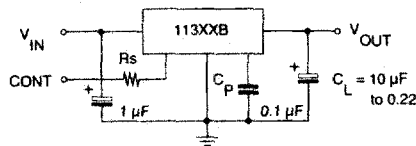

TYPICAL PERFORMANCE CHARACTERISTICS

$T_A = 25^\circ C$ unless otherwise specified

OUTPUT VOLTAGE RESPONSE (OFF \rightarrow ON)

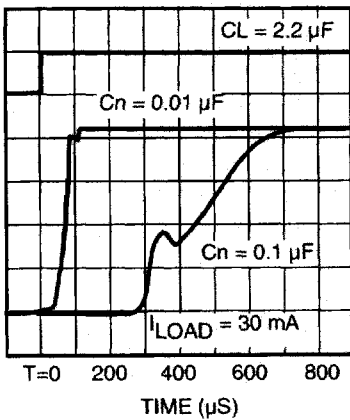

LOAD REGULATION

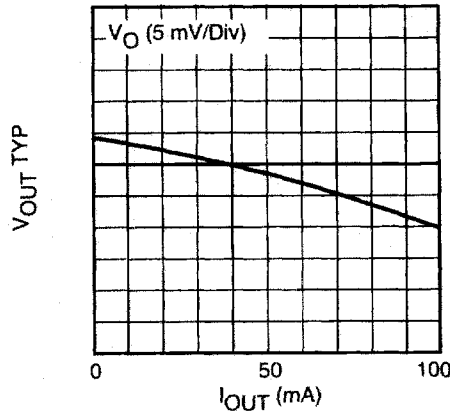

SHORT CIRCUIT CURRENT

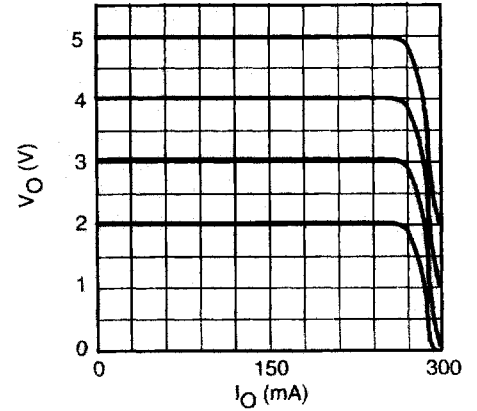

OUTPUT VOLTAGE vs. INPUT VOLTAGE

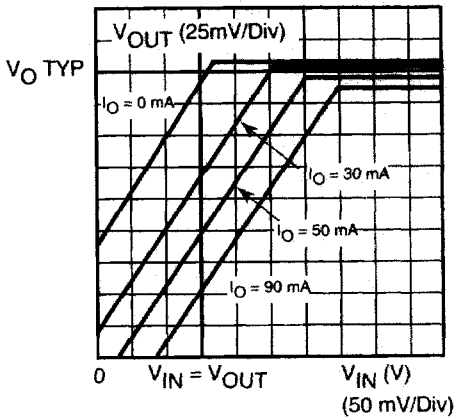

LINE REGULATION

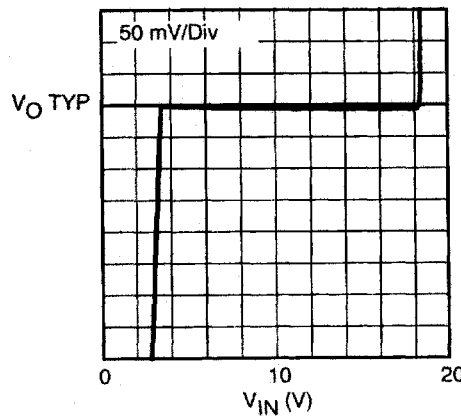

OUTPUT CURRENT vs. DROPOUT VOLTAGE

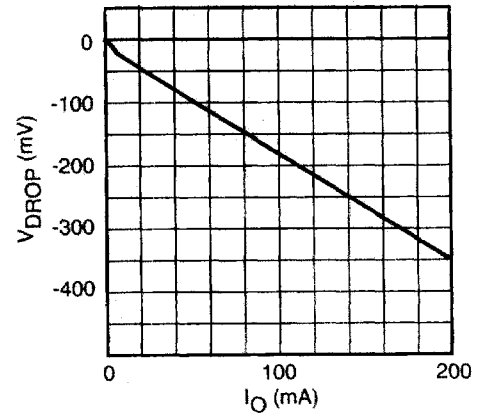

TYPICAL PERFORMANCE CHARACTERISTICS (CONT.)

$T_A = 25\text{ }^\circ\text{C}$ unless otherwise specified

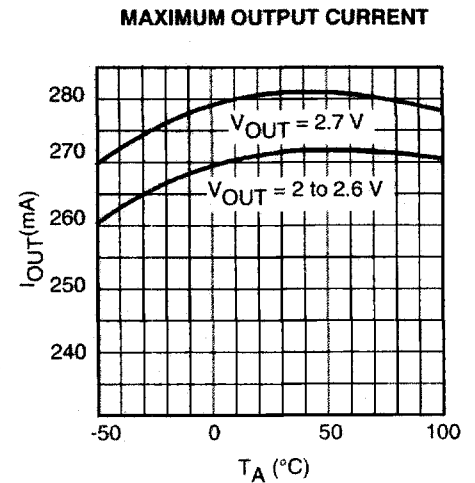
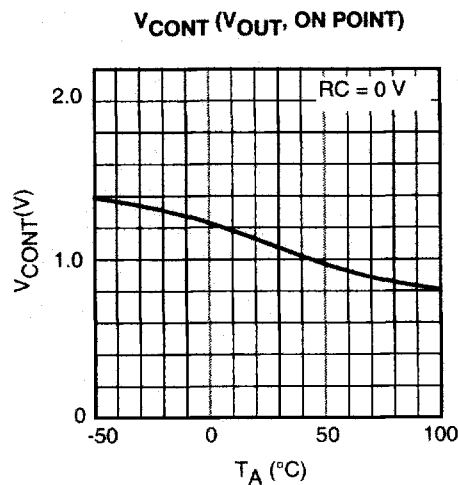
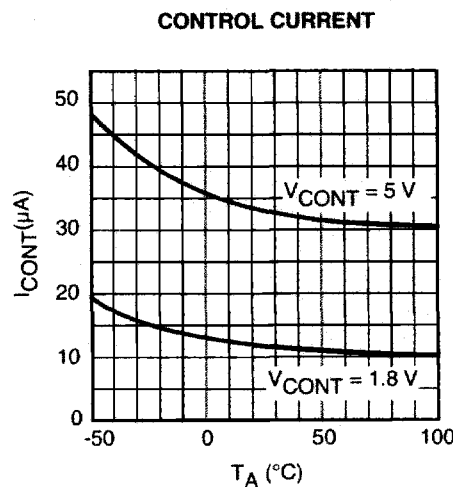
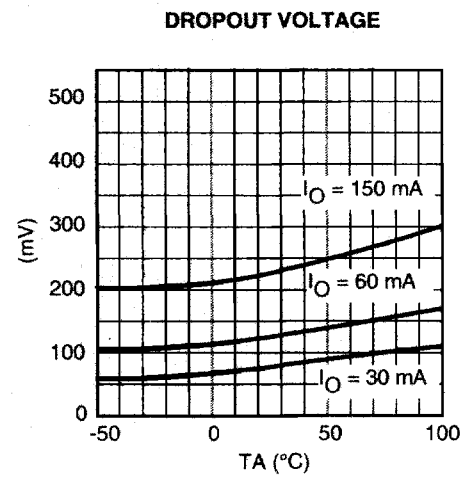
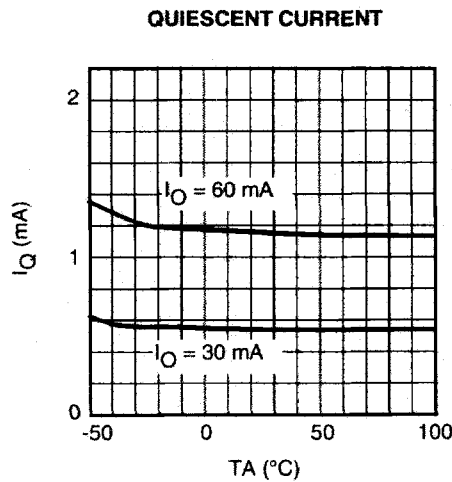
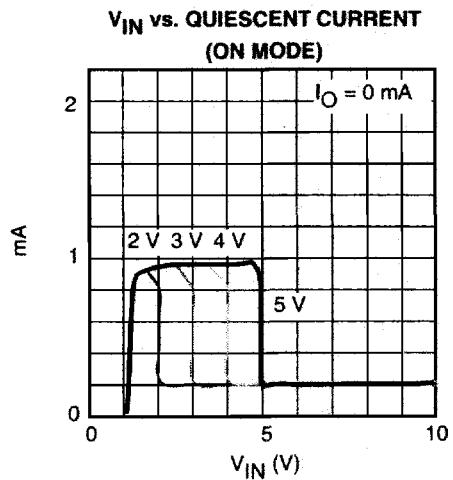
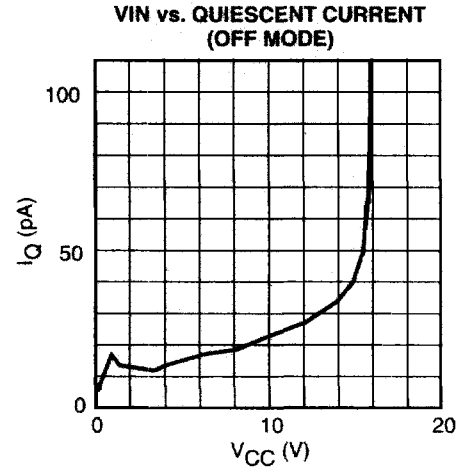
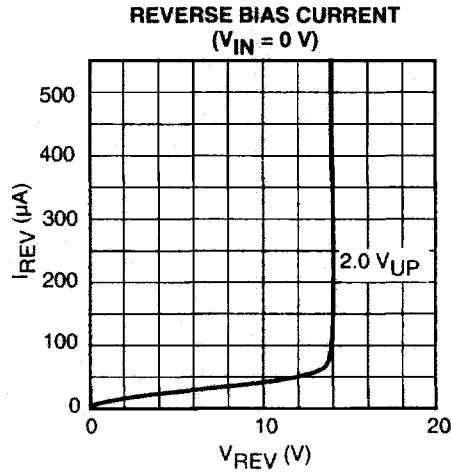
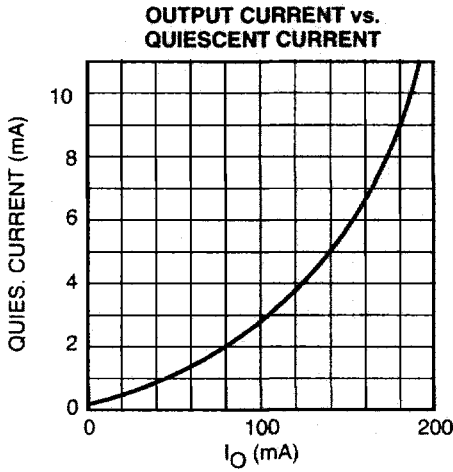

TYPICAL PERFORMANCE CHARACTERISTICS (CONT.)

$T_A = 25^\circ\text{C}$ unless otherwise specified

OUTPUT VOLTAGE VARIATION

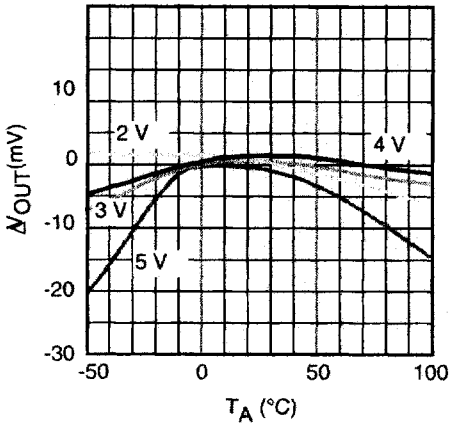

LINE VOLTAGE STEP RESPONSE

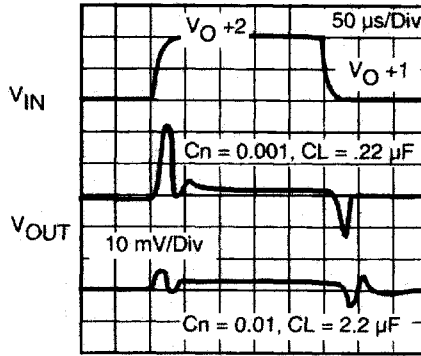

LOAD CURRENT STEP RESPONSE

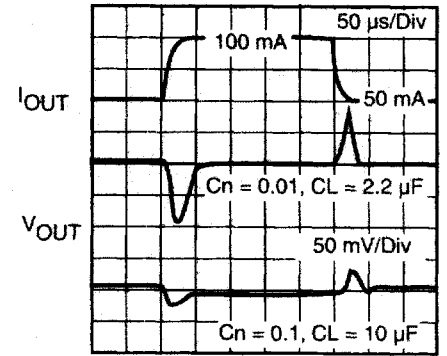

NOISE SPECTRUM

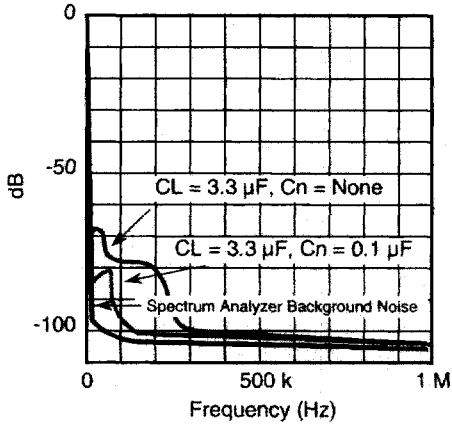

NOISE LEVEL vs. C_N

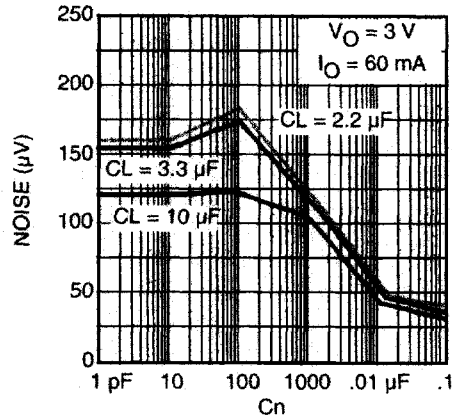

DEFINITION AND EXPLANATION OF TECHNICAL TERMS

OUTPUT VOLTAGE (V_O)

The output voltage is specified with $V_{IN} = (V_{O(TYP)} + 1 \text{ V})$ and $I_O = 30 \text{ mA}$.

DROPOUT VOLTAGE (V_{DROP})

The dropout voltage is the difference between the input voltage and the output voltage at which point the regulator starts to fall out of regulation. Below this value, the output voltage will fall as the input voltage is reduced. It is dependent upon the load current and the junction temperature.

OUTPUT CURRENT ($I_O \text{ MAX}$)

The rated output current is specified under the condition where the output voltage drops 0.3 V below the value specified with $I_O = 30 \text{ mA}$. The input voltage is set to $V_O + 1 \text{ V}$, and the current is pulsed to minimize temperature effect.

CONTINUOUS OUTPUT CURRENT (I_O)

Normal operated output current. This is limited by package power dissipation.

PULSE OUTPUT CURRENT ($I_O \text{ (PULSE)}$)

Max pulsewidth 5ms, Duty cycle 12.5%: pulse load only

LINE REGULATION (LINE REG)

Line Regulation is the ability of the regulator to maintain a constant output voltage as the input voltage changes. The line regulation is specified as the input voltage is changed from $V_{IN} = V_O + 1 \text{ V}$ to $V_{IN} = V_O + 6 \text{ V}$.

LOAD REGULATION (LOAD REG)

Load regulation is the ability of the regulator to maintain a constant output voltage as the load current changes. It is a pulsed measurement to minimize temperature effects with the input voltage set to $V_{IN} = V_O + 1 \text{ V}$. The load regulation is specified under two output current step conditions of 1 mA to 60 mA and 1 mA to 100 mA.

QUIESCENT CURRENT (I_Q)

The quiescent current is the current which flows through the ground terminal under no load conditions ($I_O = 0 \text{ mA}$)

RIPPLE REJECTION RATIO

Ripple rejection is the ability of the regulator to attenuate the ripple content of the input voltage at the output. It is specified with 100 mVrms, 400 Hz superimposed on the input voltage, where $V_{IN} = V_O + 1.5 \text{ V}$. The output decoupling capacitor is set to 10 μF , the noise bypass capacitor is set to 0.1 μF , and the load current is set to 30 mA. Ripple rejection is the ratio of the ripple content of the output vs. the input and is expressed in dB.

STANDBY CURRENT

Standby current is the current which flows into the regulator when the output is turned off by the control function ($V_{CONT} = V_{IN}$.) It is measured with $V_{IN} = 8 \text{ V}$ (9 V for the 8 V output device.)

SENSOR CIRCUIT

Over current sensor

The overcurrent sensor protects the device in the event that the output is shorted to ground.

Thermal sensor

The thermal sensor protects the device in the event that the junction temperature exceeds the safe value ($T_J = 150 \text{ }^\circ\text{C}$). This temperature rise can be caused by external heat, excessive power dissipation caused by large input to output voltage drops, or excessive output current. The regulator will shut off when the temperature exceeds the safe value. As the junction temperatures decrease, the regulator will begin to operate again. Under sustained fault conditions, the regulator output will oscillate as the device turns off then resets. Damage may occur to the device under extreme fault conditions.

Reverse Voltage Protection

Reverse voltage protection prevents damage due to the output voltage being higher than the input voltage. This fault condition can occur when the output capacitor remains charged and the input is reduced to zero, or when an external voltage higher than the input voltage is applied to the output side.

DEFINITION AND EXPLANATION OF TECHNICAL TERMS (CONT.)
CONTROL FUNCTION

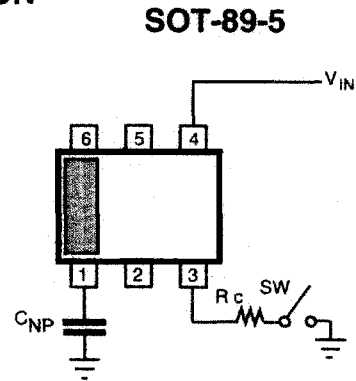
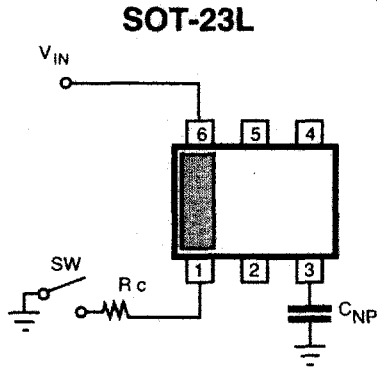

If the control function is not used, connect the control terminal to ground. When the control function is used, the control current can be reduced by inserting a series resistor (R_c) between the control terminal and V_{IN} . The value of this resistor should be determined from the graph below.

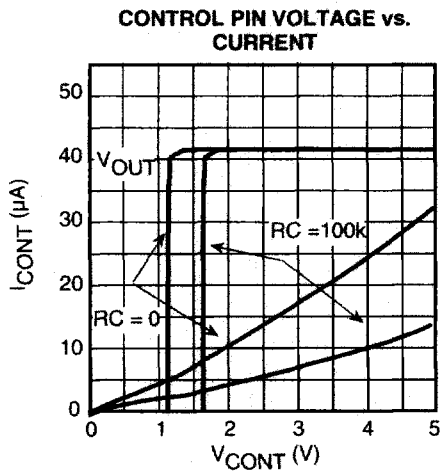

DEFINITION AND EXPLANATION OF TECHNICAL TERMS (CONT.)

ON/OFF RESPONSE WITH CONTROL AND LOAD TRANSIENT RESPONSE

The turn on time depends upon the value of the output capacitor and the noise bypass capacitor. The turn on time will increase with the value of either capacitor. The graph below shows the relationship between turn on time and load capacitance. If the value of these capacitors is reduced, the load and line regulation will suffer and the noise voltage will increase. If the value of these capacitors is increased, the turn on time will increase.

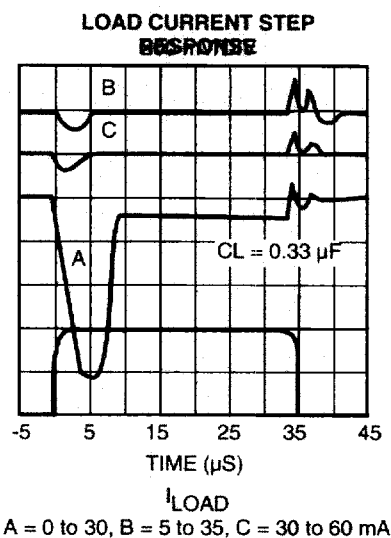
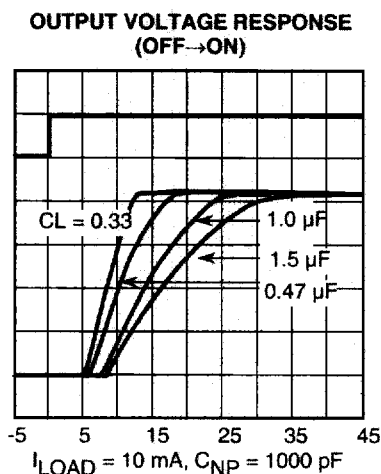

INPUT-OUTPUT CAPACITORS

Linear voltage regulators require an output capacitor to provide stable operation. If the capacitor is not present, the regulator may oscillate. The TK113 series regulators will provide stable operation with an aluminum electrolytic capacitor of 0.68 μ F or a tantalum capacitor of 0.33 μ F. In order to provide stable operation over temperature, the capacitor must have a low equivalent series resistance (ESR) over the entire operation range. It is recommended to use a capacitor larger than the minimum recommended value to insure stable operation under all load, line and temperature conditions. It is also recommended that a capacitor be used on the input side of the regulator for improved stability.

REDUCTION OF OUTPUT NOISE

Although the architecture of the Toko regulators are designed to minimize semiconductor noise, further reduction can be achieved by the selection of external components. The obvious solution is to increase the size of the output capacitor. A more effective solution would be to add a capacitor to the noise bypass terminal. The value of this capacitor should be 0.1 μ F or higher (higher values provide greater noise reduction). Although stable operation is possible without the noise bypass capacitor, this terminal has a high impedance and care should be taken to avoid a large circuit area on the printed circuit board when the capacitor is not used. Please note that several parameters are affected by the value of the capacitors and bench testing is recommended when deviating from standard values.

DEFINITION AND EXPLANATION OF TECHNICAL TERMS (CONT.)

PACKAGE POWER DISSIPATION (P_D)

This is the power dissipation level at which the thermal sensor is activated. The IC contains an internal thermal sensor which monitors the junction temperature. When the junction temperature exceeds the monitor threshold of 150 °C, the IC is shutdown. The junction temperature rises as the difference between the input power ($V_{IN} \times I_{IN}$) and the output power ($V_{OUT} \times I_{OUT}$) increases. The rate of temperature rise is greatly affected by the mounting pad configuration on the PCB, the board material, and the ambient temperature. When the IC mounting has good thermal conductivity, the junction temperature will be low even if the power dissipation is great. When mounted on the recommended mounting pad, the power dissipation of the SOT-23L is increased to 600 mW. For operation at ambient temperatures over 25 °C, the power dissipation of the SOT-23L device should be derated at 4.8 mW/°C. The power dissipation of the SOT-89-5 package is 800 mW when mounted as recommended. Derate the power dissipation at 6.4 mW/°C for operation above 25 °C. To determine the power dissipation for shutdown when mounted, attach the device on the actual PCB and deliberately increase the output current (or raise the input voltage) until the thermal protection circuit is activated. Calculate the power dissipation of the device by subtracting the output power from the input power. These measurements should allow for the ambient temperature of the PCB. The value obtained from $P_D / (150 \text{ °C} - T_A)$ is the derating factor. The PCB mounting pad should provide maximum thermal conductivity in order to maintain low device temperatures. As a general rule, the lower the temperature, the better the reliability of the device. The Thermal resistance when mounted is expressed as follows:

$$T_J = \theta_{JA} \times P_D + T_A$$

For Toko ICs, the internal limit for junction temperature is 150 °C. If the ambient temperature, T_A is 25 °C, then:

$$150 \text{ °C} = \theta_{JA} \times P_D + 25 \text{ °C}$$

$$\theta_{JA} \times P_D = 125 \text{ °C}$$

$$\theta_{JA} = 125 \text{ °C} / P_D$$

P_D is the value when the thermal sensor is activated. A simple way to determine P_D is to calculate $V_{IN} \times I_{IN}$ when the output side is shorted. Input current gradually falls as temperature rises. You should use the value when thermal equilibrium is reached.

The range of currents usable can also be found from the graph below.

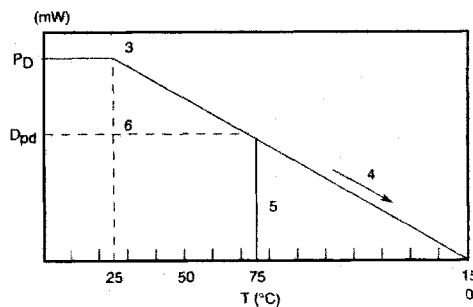

Procedure:

- 1.) Find P_D
- 2.) P_{D1} is taken to be $P_D \times (\approx 0.8 \sim 0.9)$
- 3.) Plot P_{D1} against 25 °C
- 4.) Connect P_{D1} to the point corresponding to the 150 °C with a straight line.
- 5.) In design, take a vertical line from the maximum operating temperature (e.g. 75 °C) to the derating curve.
- 6.) Read off the value of P_D against the point at which the vertical line intersects the derating curve. This is taken as the maximum power dissipation, D_{PD} .

The maximum operating current is:

$$I_{OUT} = (D_{PD} / (V_{IN(MAX)} - V_{OUT}))$$

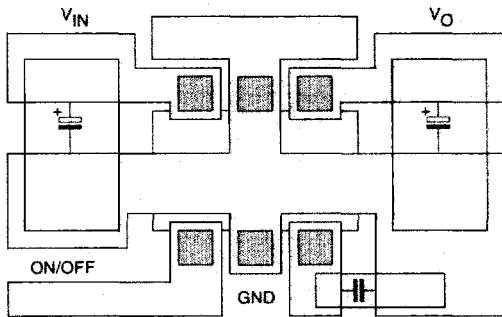

SOT-23L Board Layout

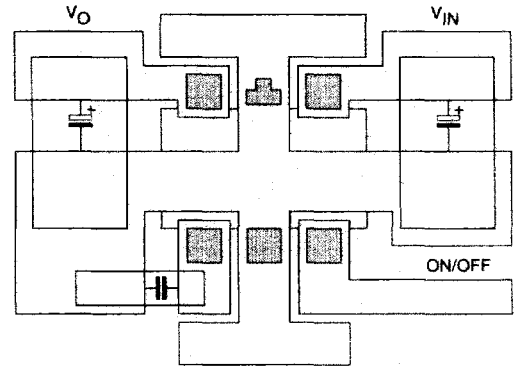

SOT-89-5 Board Layout

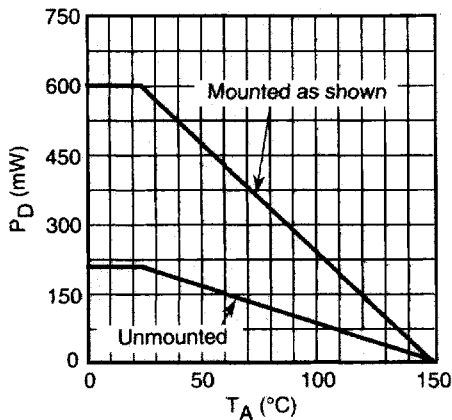

SOT-23L Power Dissipation Curve

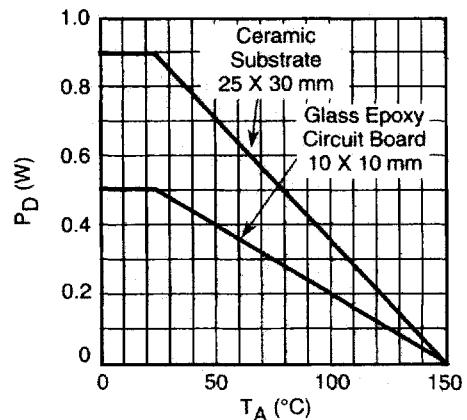

SOT-89-5 Power Dissipation Curve

APPLICATION HINTS

Copper pattern should be as large as possible. Power dissipation is 400 mW for SOT-23L and 800 mW for SOT-89-5. A low ESR capacitor is recommended. For low temperature operation, select a capacitor with a low ESR at the lowest operating temperature to prevent oscillation, degradation of ripple rejection and increase in noise. The minimum recommended capacitance is 2.2 μF.

TK113xxB

PACKAGE OUTLINE

SOT-23L

(Pin 2 and pin 5 should be grounded for heat dissipation)

Marking Information

Product Code	Q
TK11320B	20
TK11321B	21
TK11322B	22
TK11323B	23
TK11324B	24
TK11325B	25
TK11326B	26
TK11327B	27
TK11328B	28
TK11329B	29
TK11330B	30
TK11331B	31
TK11332B	32
TK11333B	33
TK11334B	34
TK11335B	35
TK11336B	36
TK11337B	37
TK11338B	38
TK11339B	39
TK11340B	40
TK11341B	41
TK11342B	42
TK11343B	43
TK11344B	44
TK11345B	45
TK11346B	46
TK11347B	47
TK11348B	48
TK11349B	49
TK11350B	50
TK11355B	55
TK11360B	60
TK11390B	80

SOT-89-5

The information furnished by TOKO, Inc. is believed to be accurate and reliable. However, TOKO reserves the right to make changes or improvements in the design, specification or manufacture of its products without further notice. TOKO does not assume any liability arising from the application or use of any product or circuit described herein, nor for any infringements of patents or other rights of third parties which may result from the use of its products. No license is granted by implication or otherwise under any patent or patent rights of TOKO, Inc.



TOKO AMERICA REGIONAL OFFICES

Midwest Regional Office
 Toko America, Inc.
 1250 Feehanville Drive
 Mount Prospect, IL 60056
 Tel: (847) 297-0070
 Fax: (847) 699-7864

Western Regional Office
 Toko America, Inc.
 2480 North First Street, Suite 260
 San Jose, CA 95131
 Tel: (408) 432-8281
 Fax: (408) 943-9790

Eastern Regional Office
 Toko America, Inc.
 107 Mill Plain Road
 Danbury, CT 06811
 Tel: (203) 748-6871
 Fax: (203) 797-1223

Semiconductor Technical Support
 Toko Design Center
 4755 Forge Road
 Colorado Springs, CO 80907
 Tel: (719) 528-2200
 Fax: (719) 528-2375

<http://www.tokoam.com>

IC-214-TK113B
 059702500